

UKP2 (Normal-duty)

Pillow Blocks

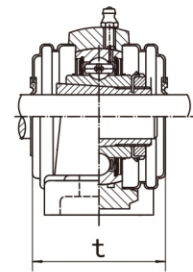
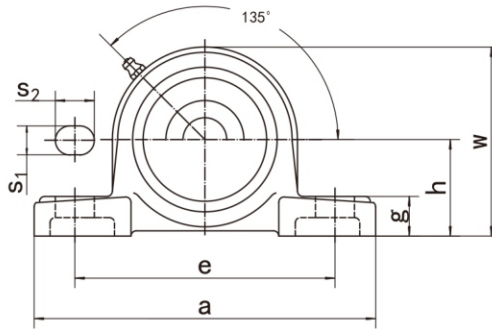
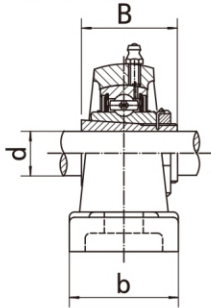

UKP-C₁(D₁)

Unit NO.	Dimensions (mm / in.)											Bolt Size mm/in.	Bearing No.	Housing No.	Weight (kg)
	d	h	a	e	b	s ₁	s ₂	g	w	t	B				
UKP205;H2305 205;HE2305	20 3/4	36.5 1-7/16	140 5-1/2	105 4-1/8	38 1-1/2	13 1/2	19 3/4	15 19/32	71 2-25/32	48 1-57/64	35 1.378	M10 3/8	UK205;H2305 UK205;HE2305	P205	0.81
UKP206;H2306 206;HS2306 206;HE2306	25 7/8 1	42.9 1-11/16	160 6-9/64	121 4-3/4	44 1-47/64	17 43/64	20 25/32	17 43/64	84 3-5/16	53 2-5/64	38 1.496	M14 1/2	UK206;H2306 UK206;HS2306 UK206;HE2306	P206	1.26
UKP207;H2307 207;HS2307	30 1-1/8	47.6 1-7/8	167 6-9/16	127 5	48 1-7/8	17 43/64	20 25/32	18 45/64	93 3-21/32	59.5 2-11/32	43 1.693	M14 1/2	UK207;H2307 UK207;HS2307	P207	1.53
UKP208;H2308 208;HE2308 208;HS2308	35 1-1/4 1-3/8	49.2 1-15/16	184 7-1/4	137 5-13/32	54 2-1/8	17 43/64	20 25/32	18 45/64	100 3-15/16	69 2-23/32	46 1.811	M14 1/2	UK208;H2308 UK208;HE2308 UK208;HS2308	P208	1.93
UKP209;H2309 209;HA2309 209;HE2309 209;HS2309	40 1-7/16 1-1/2 1-5/8	54.0 2-1/8	190 7-15/32	146 5-3/4	54 2-1/8	17 43/64	20 25/32	20 25/32	106 4-11/64	69 2-23/32	50 1.969	M14 1/2	UK209;H2309 UK209;HA2309 UK209;HE2309 UK209;HS2309	P209	2.18
UKP210;H2310 210;HS2310 210;HA2310 210;HE2310	45 1-5/8 1-11/16 1-3/4	57.2 2-1/4	206 8-1/8	159 6-1/4	60 2-3/8	20 25/32	23 29/32	21 53/64	113 4-29/64	74.5 2-15/16	55 2.165	M16 5/8	UK210;H2310 UK210;HS2310 UK210;HA2310 UK210;HE2310	P210	2.78
UKP211;H2311 211;HS2311 211;HA2311 211;HE2311	50 1-7/8 1-15/16 2	63.5 2-1/2	219 8-5/8	171 6-47/64	60 2-3/8	20 25/32	23 29/32	23 29/32	125 4-59/64	76 3	59 2.323	M16 5/8	UK211;H2311 UK211;HS2311 UK211;HA2311 UK211;HE2311	P211	3.39
UKP212;H2312 212;HS2312	55 2-1/8	69.8 2-3/4	241 9-1/2	184 7-1/4	70 2-3/4	20 25/32	23 29/32	25 63/64	138 5-7/16	89 3-1/2	62 2.441	M16 5/8	UK212;H2312 UK212;HS2312	P212	4.52
UKP213;H2313 213;HA2313 213;HE2313 213;HS2313	60 2-3/16 2-1/4 2-3/8	76.2 3	265 10-7/16	203 8	70 2-3/4	25 63/64	28 1-3/32	27 1-1/16	150 5-29/32	89 3-1/2	65 2.559	M20 3/4	UK213;H2313 UK213;HA2313 UK213;HE2313 UK213;HS2313	P213	5.47
UKP215;H2315 215;HA2315 215;HE2315	65 2-7/16 2-1/2	82.6 3-1/4	275 10-53/64	217 8-35/64	74 2-29/32	25 63/64	28 1-3/32	28 1-3/32	162 6-3/8	99 3-57/64	73 2.874	M20 3/4	UK215;H2315 UK215;HA2315 UK215;HE2315	P215	6.84
UKP216;H2316 216;HA2316 216;HE2316	70 2-11/16 2-3/4	88.9 3-1/2	292 11-1/2	232 9-1/8	78 3-1/16	25 63/64	28 1-3/32	30 1-3/16	174 6-27/32	109 4-19/64	78 3.071	M20 3/4	UK216;H2316 UK216;HA2316 UK216;HE2316	P216	8.29
UKP217;H2317 217;HA2317 217;HE2317	75 2-15/16 3	95.2 3-3/4	310 12-13/64	247 9-23/32	83 3-17/64	25 63/64	28 1-3/32	32 1-1/4	185 7-9/32	113.2 4-29/64	82 3.228	M20 3/4	UK217;H2317 UK217;HA2317 UK217;HE2317	P217	9.97
UKP218;H2318 218;HA2318	80 3-3/16	101.6 4	327 12-7/8	262 10-5/16	88 3-15/32	27 1-1/16	30 1-3/16	33 1-19/64	198 7-51/64	123 4-27/32	86 3.386	M22 7/8	UK218;H2318 UK218;HA2318	P218	11.89